



1. Ecrire entre les lignes : to, ta, tu, ti, té.

to, ta, tu, ti, té.

to, ta, tu, ti, té.

2. Colorier les triangles qui contiennent la lettre «t».

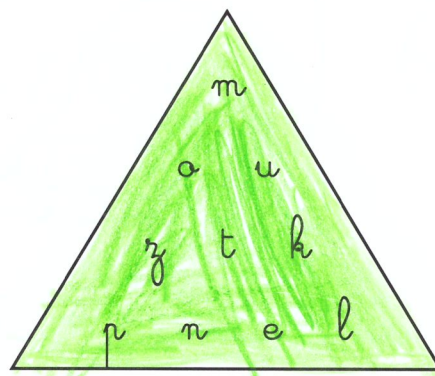
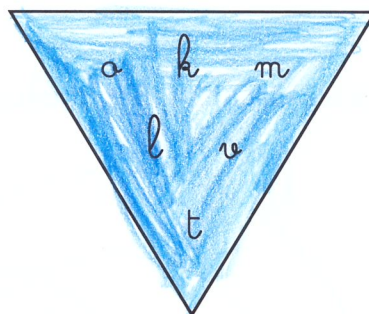
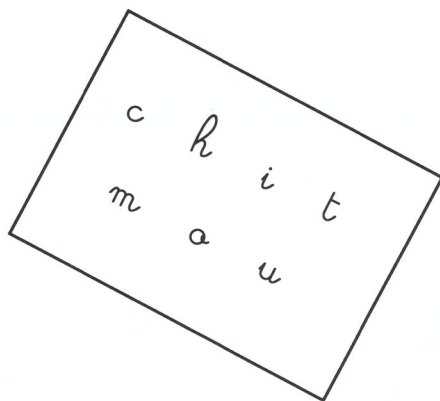
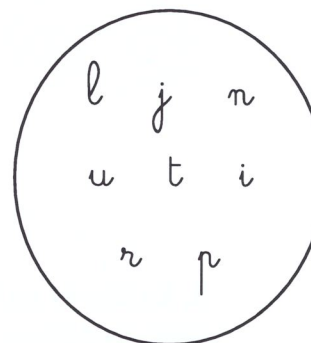
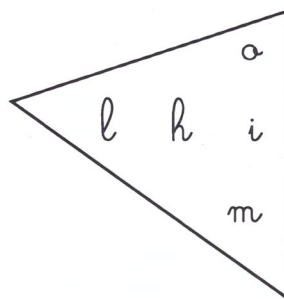
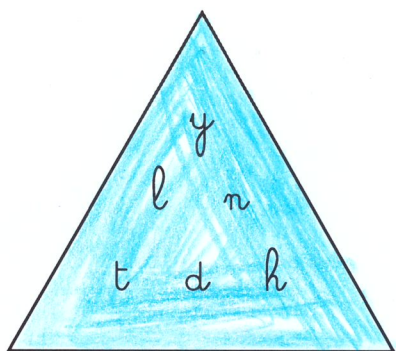

3. Addition : dessiner le nombre total de moutons, puis compléter l'addition.

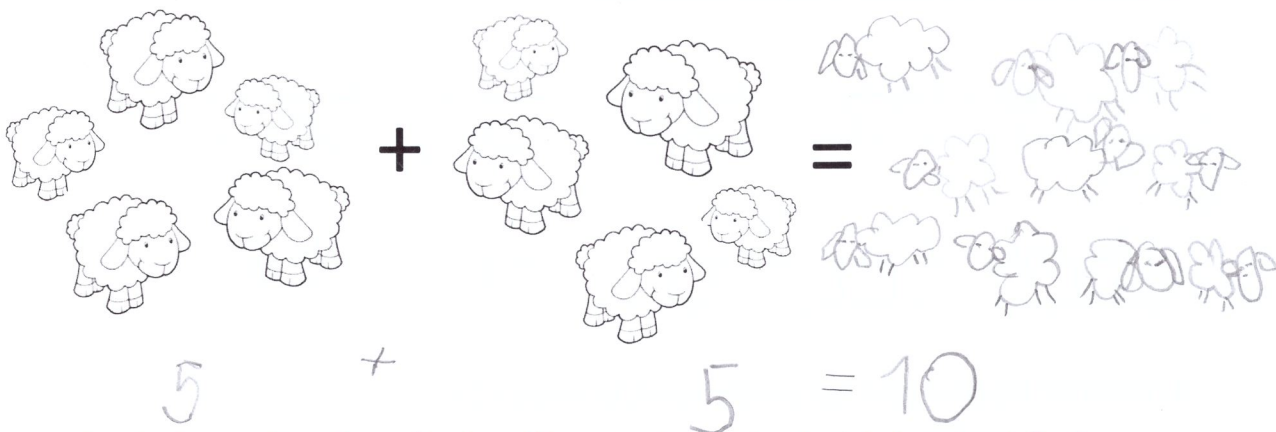

4. Colorier les jouets les plus près du coffre et entourer les jouets les plus loin du coffre.

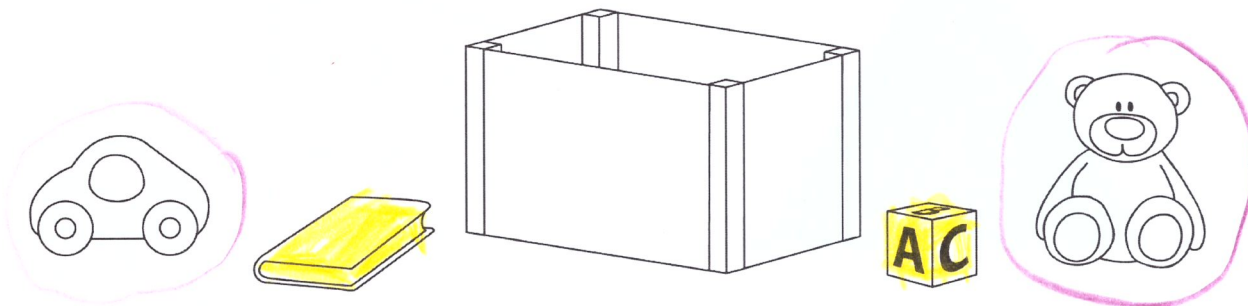

5. Entourer en bleu les biscuits qui sont dans l'assiette et colorier en rouge ceux qui sont en dehors.

